

TELAIO FILL

Fill frame
Marco Fill
Cadre Fill
Рамка Fill

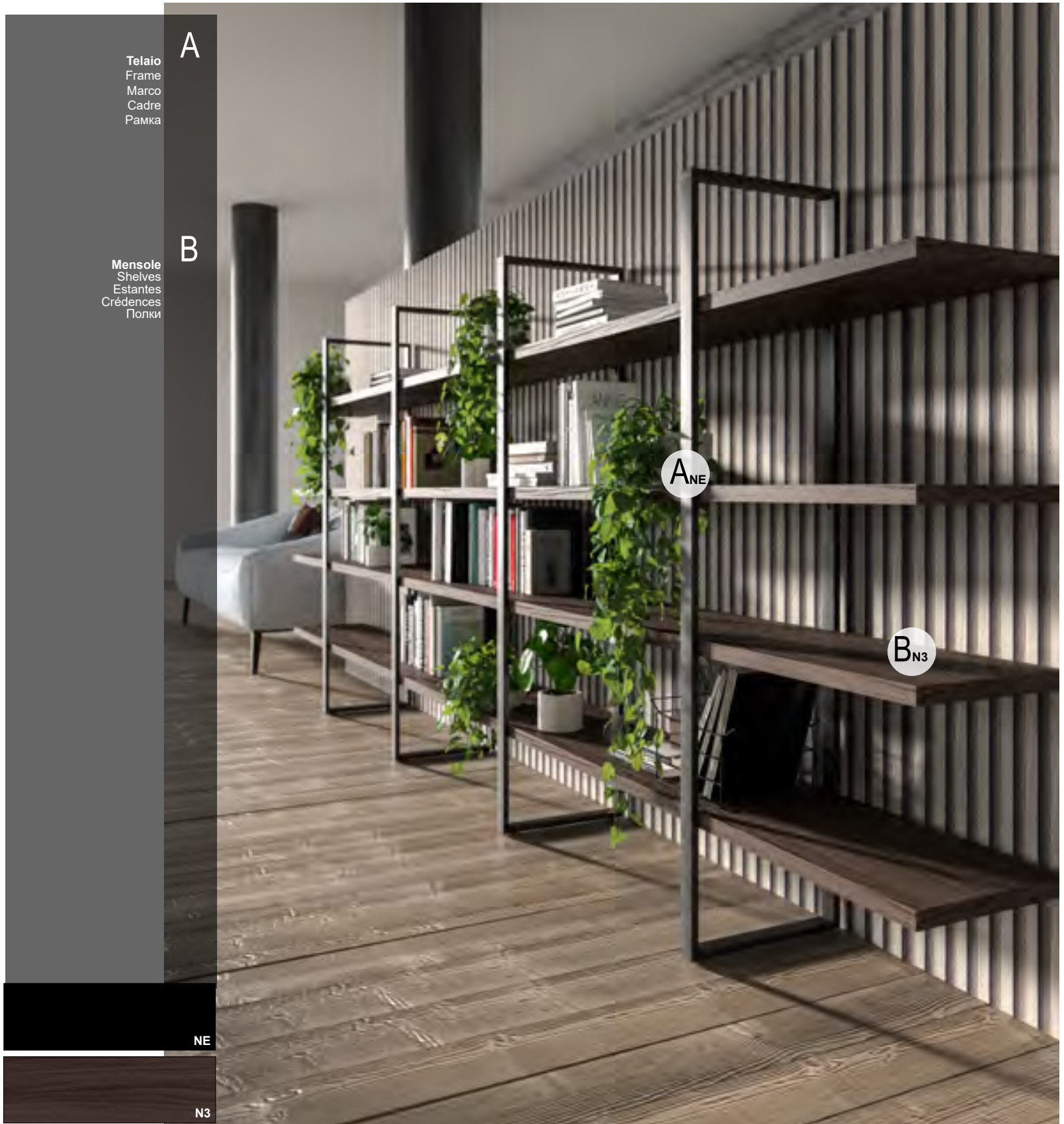

A
Telaio
Frame
Marco
Cadre
Рамка

B
Mensole
Shelves
Estantes
Crédences
Полки

NE

N3

Caratteristiche tecniche
 Technical features
 Sección técnica
 Caractéristiques techniques
 Технический раздел



Telaio profondità 34,9 cm
 frame depth 34,9 cm
 profundidad del marco 34,9 cm
 profondeur du cadre 34,9 cm
 глубина рамы 34 см

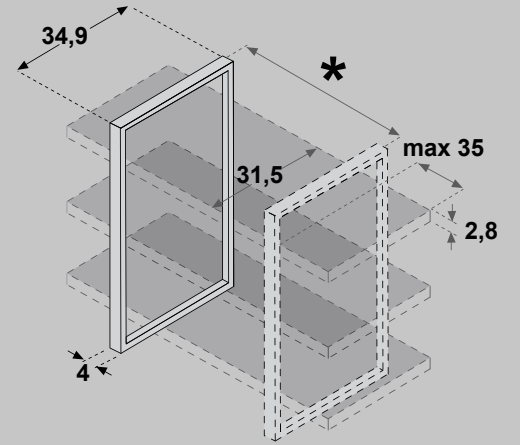

*** Attenzione la distanza tra due telai non deve essere maggiore di 90 cm.**
 Attention: the distance between two frame should not be more than 90 cm.
 Atención la distancia entre los dos marcos no debe ser superior a 90 cms.
 Attention: la distance entre les deux cadres ne doivent pas être supérieure de 90 cm.
 Внимание расстояние между двумя рамками не должно превышать 90 см.

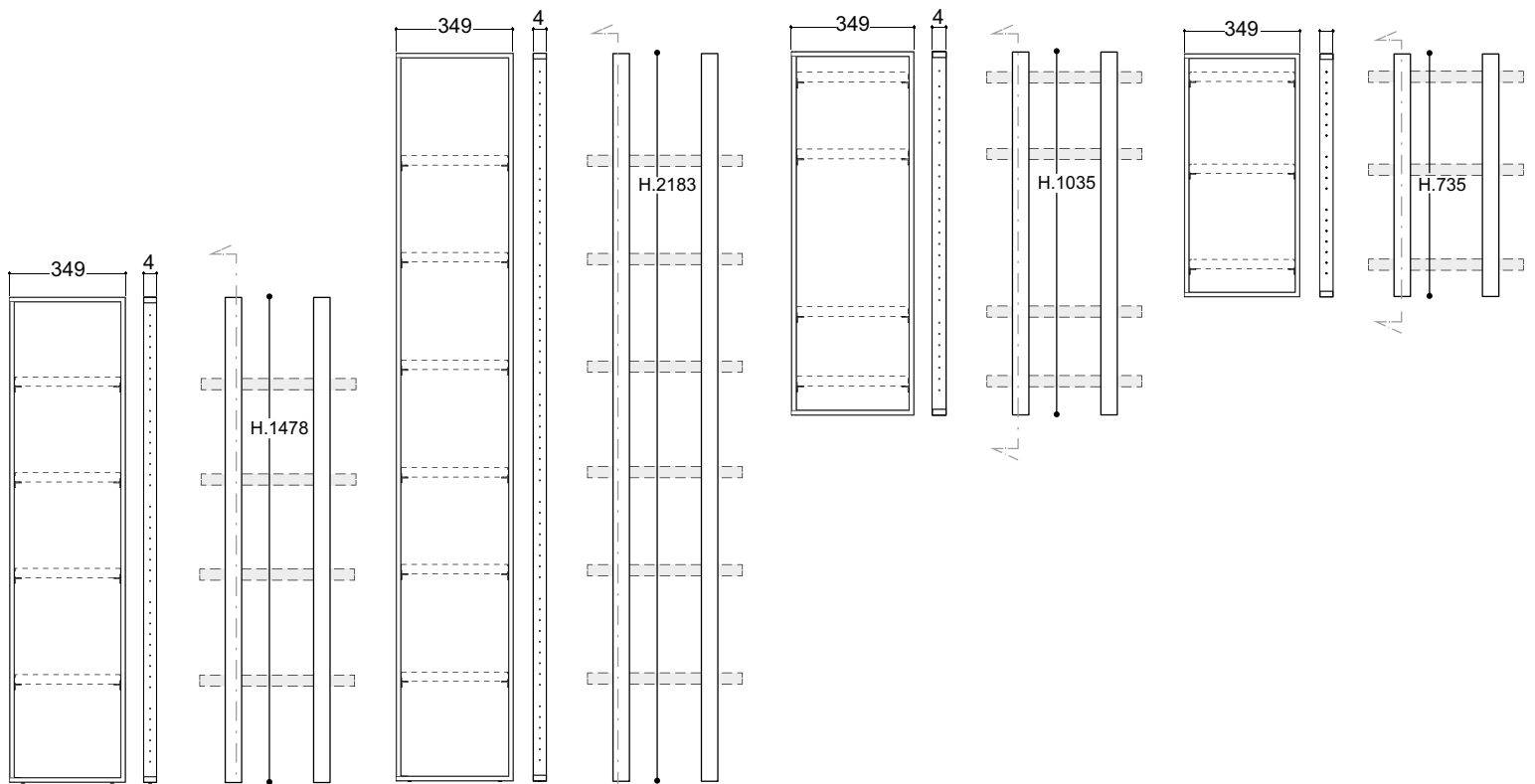

LA

Telaio a terra
 End floor Frame System
 Marco a ras del suelo
 Cadre avec montant au sol
 Напольной Рамка

LM

Telaio a terra
 End floor Frame System
 Marco a ras del suelo
 Cadre avec montant au sol
 Напольной Рамка

LO

Telaio sospeso
 suspended Frame System
 Marco suspendido
 Cadre suspendu
 подвесной Рамка

LP

Telaio sospeso
 suspended Frame System
 Marco suspendido
 Cadre suspendu
 подвесной Рамка

Caratteristiche tecniche

Technical features

Sección técnica

Caractéristiques techniques

Технический раздел

Telaio profondità 39,4cm

frame depth 39,4 cm

profundidad del marco 39,4 cm

profondeur du cadre 39,4 cm

глубина рамы 39,4 см

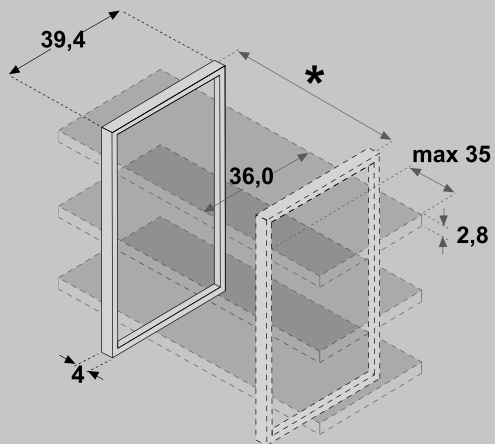

E' espressamente consigliato fissare i telai al muro.

It's expressly recommended fixing the frame to the wall.

Es aconsejado expresamente y atornillar los marcos a la pared.

Il est expressément conseillé de fixer les cadres au mur.

Настоятельно рекомендуется фиксировать металлические рамы к стене.

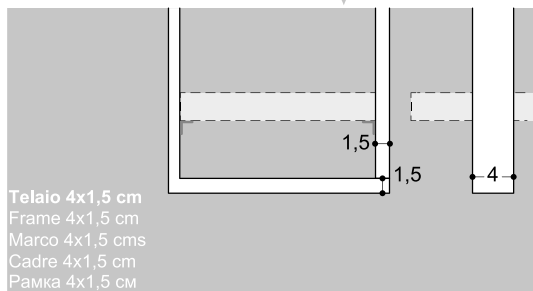
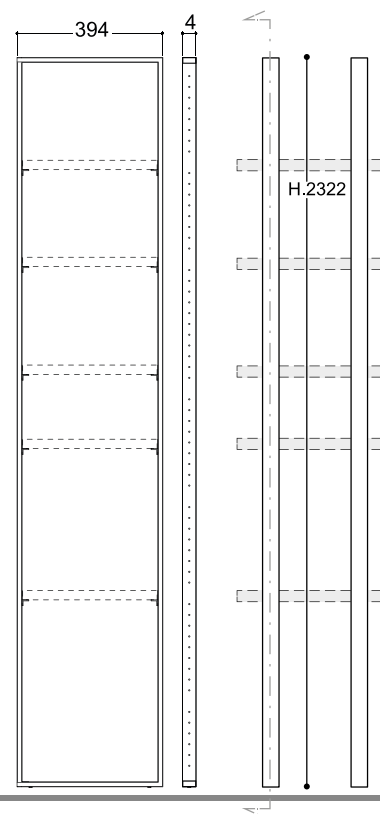
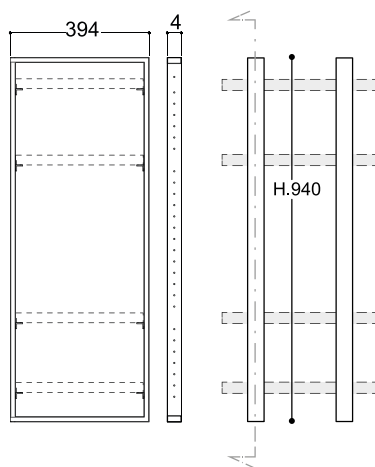
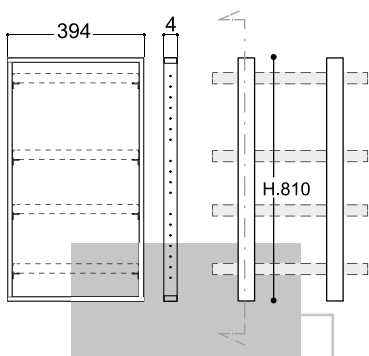
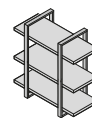

Telaio 4x1,5 cm
Frame 4x1,5 cm
Marco 4x1,5 cms
Cadre 4x1,5 cm
Рамка 4x1,5 см

LB

Telaio sospeso
suspended Frame System
Marco suspendido
Cadre suspendu
подвесной Рамка

LE

Telaio sospeso
suspended Frame System
Marco suspendido
Cadre suspendu
подвесной Рамка

LH

Telaio a terra
End floor Frame System
Marco a ras del suelo
Cadre avec montant au sol
Напольной Рамка

Finiture Fill

Fill finishes
Acabados Fill
Finitions Fill
Отделки Fill

Telaio 4x1,5 cm

Frame 4x1,5 cm
Marco 4x1,5 cm
Cadre 4x1,5 cm
Рамка 4x1,5 cm

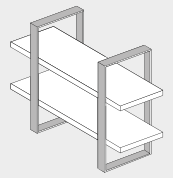

NE

Nero
Black
Negro
Noir
Черный

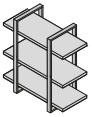

Mensole profondità 31.5 / 36.0 H. 2.8 cm, lunghezza massima 270 cm

Shelves, 31.5 / 36.0 depth H. 2.8 cm, maximum length 270 cm
Estantes profundidad 31.5 / 36.0 H. 2.8 cms, longitud máxima 270 cm
Crédences profondeur 31.5 / 36.0 H. 2.8 cm, longueur maximale 270 cm
Полки глубиной 31.5 / 36.0 H. 2.8 см, максимальная длина 270 см

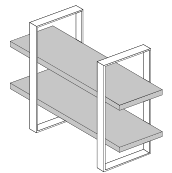

Mensole in melaminico

Melamine shelves
Estantes en melamina
Crédences en mélamine
Полки из меламина

Bianco Seta BT **Noce Corteccia** N2 **Noce Solenne** N3 **Rovere Nuova Zelanda** YW

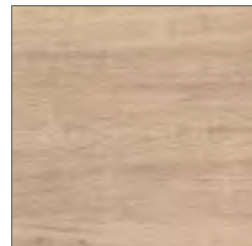
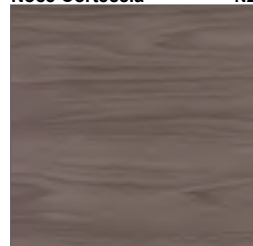
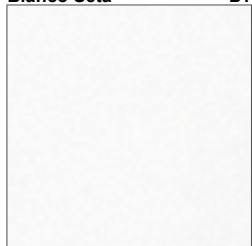

Telaio Fill
Fill profile
Marco Fill
Cadre Fill
Рамка Fill

Listino prezzi
Price list
Listado de precio
Liste de prix
Прайс лист

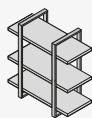







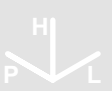

Telaio Fill, Profondità 36 cm

Fill profile, 35 cm depth

Marco Fill, Profundidad 35 cm

Cadre Fill, Profondeur 35 cm

Рамка Fill, Глубина 35 см

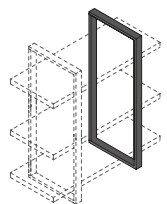
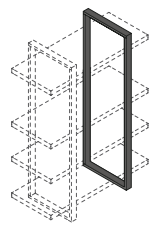
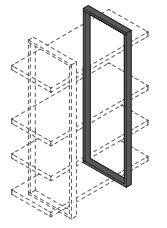
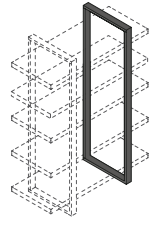
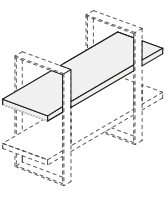
		Descrizione / Elemento Description / Element Descripción / Elemento Description / Élément Описание / Элемент	 Dimensioni Dimensions Dimensiones Размеры	 Peso Weight Peso Poids Вес	 Volume Volume Volumen Volume Объем	 Colli Parcels Bultos Colis Упаковка	 Punti Points Puntos Points Пунктах	 Codice Code Código Code Код	 Finiture Finishes Acabados Finitions Отделка			
	Telaio 4x1,5 cm per uso reggimensola - 3 mensole	H 73,5	3	0,010	1	192	FI7335NE	Telaio	Frame	Marco	Châssis	Рамка
	Shelf bracket profile, section 4x1,5 cm - 3 shelves											
	Marco 4x1,5 cms para uso portaestante - 3 estantes											
	Cadre 4x1,5 cm pour utilisation supports étagère - 3 crédences											
	Рамка 4x1,5 см используется в качестве крепежей для менсолы- 3 полки											
P 34,9 Sp 4												
	Telaio 4x1,5 cm per uso reggimensola - 4 mensole	H 103,5	3,5	0,015	1	226	FI10335NE	Telaio	Frame	Marco	Châssis	Рамка
	Shelf bracket profile, section 4x1,5 cm - 4 shelves											
	Marco 4x1,5 cms para uso portaestante - 4 estantes											
	Cadre 4x1,5 cm pour utilisation supports étagère - 4 crédences											
	Рамка 4x1,5 см используется в качестве крепежей для менсолы - 4 полки											
P 34,9 Sp 4												
	Telaio 4x1,5 cm per uso reggimensola - 4 mensole	H 147,8	4,5	0,020	1	301	FI14735NE	Telaio	Frame	Marco	Châssis	Рамка
	Shelf bracket profile, section 4x1,5 cm - 4 shelves											
	Marco 4x1,5 cms para uso portaestante - 4 estantes											
	Cadre 4x1,5 cm pour utilisation supports étagère - 4 crédences											
	Рамка 4x1,5 см используется в качестве крепежей для менсолы - 4 полки											
P 34,9 Sp 4												
	Telaio 4x1,5 cm per uso reggimensola - 6 mensole	H 218,3	6	0,030	1	437	FI21835NE	Telaio	Frame	Marco	Châssis	Рамка
	Shelf bracket profile, section 4x1,5 cm - 6 shelves											
	Marco 4x1,5 cms para uso portaestante - 6 estantes											
	Cadre 4x1,5 cm pour utilisation supports étagère - 6 crédences											
	Рамка 4x1,5 см используется в качестве крепежей для менсолы - 6 полки											
P 34,9 Sp 4												
	Mensola in Melaminico	L m.l.	7,5	0,015	1	49	FIM31L1	Mensola	Shelf	Estante	Etagère	Полка
	Melamine shelf											
	Estante en melamina											
	Etagère en mélamine											
	Полки из меламиновой панели											
P 31,5 Sp 2,8												







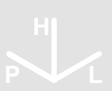

Telaio Fill, Profondità 39 cm

Fill profile, 39 cm depth

Marco Fill, Profundidad 39 cm

Cadre Fill, Profondeur 39 cm

Рамка Fill, Глубина 39 см

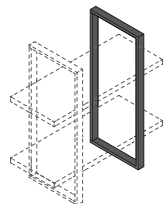
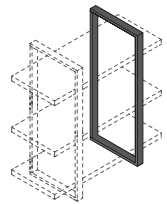
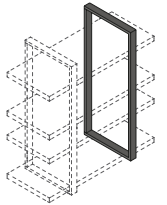
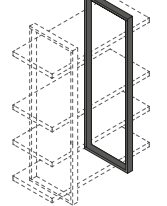
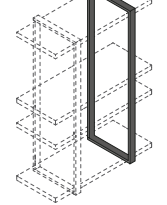
		Descrizione / Elemento Description / Element Descripción / Elemento Description / Élément Описание / Элемент	 Dimensioni Dimensions Dimensiones Размеры	 Peso Weight Peso Poids Вес	 Volume Volumen Volumen Объем	 Collis Parcels Bultos Colis Упаковка	 Punti Points Puntos Points Пунктах	 Codice Code Código Code Код	 Finiture Acabados Finitions Отделка
	Telaio 4x1,5 cm per uso reggimensola - 2 mensole Shelf bracket profile, section 4x1,5 cm - 2 shelves Marco 4x1,5 cms para uso portaestante - 2 estantes Cadre 4x1,5 cm pour utilisation supports étagère - 2 crédences Рамка 4x1,5 см используется в качестве крепежей для менсолы - 2 полки	H	81	1,6	0,013	1	208	FI8139LD2NE	Telaio Frame Marco Châssis Рамка
P 39 Sp 4									
	Telaio 4x1,5 cm per uso reggimensola - 3 mensole Shelf bracket profile, section 4x1,5 cm - 3 shelves Marco 4x1,5 cms para uso portaestante - 3 estantes Cadre 4x1,5 cm pour utilisation supports étagère - 3 crédences Рамка 4x1,5 см используется в качестве крепежей для менсолы - 3 полки	H	81	1,6	0,013	1	208	FI8139LC3NE	Telaio Frame Marco Châssis Рамка
P 39 Sp 4									
	Telaio 4x1,5 cm per uso reggimensola - 4 mensole Shelf bracket profile, section 4x1,5 cm - 4 shelves Marco 4x1,5 cms para uso portaestante - 4 estantes Cadre 4x1,5 cm pour utilisation supports étagère - 4 crédences Рамка 4x1,5 см используется в качестве крепежей для менсолы - 4 полки	H	81	1,6	0,013	1	208	FI8139LB4NE	Telaio Frame Marco Châssis Рамка
P 39 Sp 4									
	Telaio 4x1,5 cm per uso reggimensola - 4 mensole Shelf bracket profile, section 4x1,5 cm - 4 shelves Marco 4x1,5 cms para uso portaestante - 4 estantes Cadre 4x1,5 cm pour utilisation supports étagère - 4 crédences Рамка 4x1,5 см используется в качестве крепежей для менсолы - 4 полки	H	94	1,8	0,015	1	211	FI9439LE4NE	Telaio Frame Marco Châssis Рамка
P 39 Sp 4									
	Telaio 4x1,5 cm per uso reggimensola - 4 mensole Shelf bracket profile, section 4x1,5 cm - 4 shelves Marco 4x1,5 cms para uso portaestante - 4 estantes Cadre 4x1,5 cm pour utilisation supports étagère - 4 crédences Рамка 4x1,5 см используется в качестве крепежей для менсолы - 4 полки	H	94	1,8	0,015	1	211	FI9439LF4NE	Telaio Frame Marco Châssis Рамка
P 39 Sp 4									

Telaio Fill, Profondità 39 cm

Fill profile, 39 cm depth

Marco Fill, Profundidad 39 cm

Cadre Fill, Profondeur 39 cm

Рамка Fill, Глубина 39 см



		Descrizione / Elemento Description / Element Descripción / Elemento Description / Élément Описание / Элемент	Dimensioni Dimensions Dimensiones Размеры	Peso Weight Peso Poids Вес	Volume Volume Volumen Volume Объем	Colli Parcels Bultos Colis Упаковка	Punti Points Puntos Points Пунктах	Codice Code Código Code Код	Finiture Finishes Acabados Finitions Отделка	
	P 39 Sp 4	Telaio 4x1,5 cm per uso reggimensola - 5 mensole Shelf bracket profile, section 4x1,5 cm - 5 shelves Marco 4x1,5 cms para uso portaestante - 5 estantes Cadre 4x1,5 cm pour utilisation supports étagère - 5 crédences Рамка 4x1,5 см используется в качестве крепежей для менсолы - 5 полки	H	232	3,6	0,036	1	410	FI2339LH4NE	Telaio Frame Marco Châssis Рамка
	P 36 Sp 2,8	Mensola in Melaminico Melamine shelf Estante en melamina Étagère en mélamine Полки из меламиновой панели	L	m.l.	7,5	0,015	1	55	FIM36L1	Mensola Shelf Estante Étagère Полка